

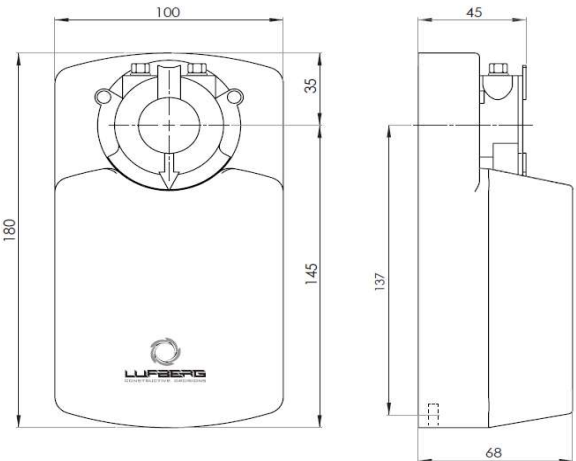
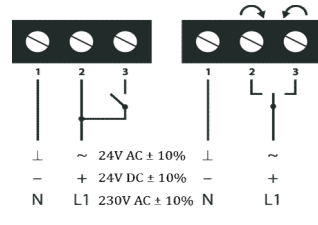
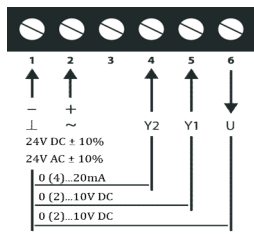
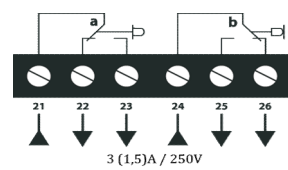
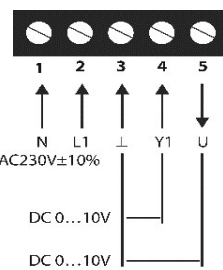

Actuator without spring return DA08N..., DA16N..., DA24N...

Type overview					
Torque	Damper surface	Voltage	Auxiliary switches	2/3 point control type	Modulating control type
8Nm	< 1,6m ² *	24V AC/DC	-	DA08N24	DA08N24PI
			2 SPDT**	DA08N24S	DA08N24PIS
		230V AC	-	DA08N220	DA08N220P
			2 SPDT**	DA08N220S	DA08N220PS
16Nm	< 3,2m ² *	24V AC/DC	-	DA16N24	DA16N24PI
			2 SPDT**	DA16N24S	DA16N24PIS
		230V AC	-	DA16N220	DA16N220P
			2 SPDT**	DA16N220S	DA16N220PS
24Nm	< 4,8m ² *	24V AC/DC	-	DA24N24	DA24N24PI
			2 SPDT**	DA24N24S	DA24N24PIS
		230V AC	-	DA24N220	DA24N220P
			2 SPDT**	DA24N220S	DA24N220PS

Technical specification				
Type	DAxxN24x	DAxxN220x	DAxxN24PIx	DAxxN220Px
Torque	8Nm / 16Nm / 24Nm			
Running time - motor	30-40s / 70-95s / 115-160s			
Controls	2/3 point		0(2)-10V/0(4)-20mA DC	0 -10V DC
Voltage	24V AC/DC	230V AC	24V AC/DC	230V AC
Frequency	50/60Hz (AC)			
Power consumption				
- in operation	4,5W	4,8W	4,5W	4,8W
- at rest	0,4W	1,2W	0,7W	1,0W
- for wire sizing	6,5VA	6,5VA	6,5VA	10,0VA
Angle of rotation	0~90°			
- setting	5°~85° (5° step)			
Direction of rotation	by turn of the motor cable connector		by switch inside of the actuator	
Weight	1,1 kg			
Sound power level - motor	<45 dB(A)			
Position feedback	-	-	0(2)-10V DC	0 -10V DC
Electrical connection	terminal in actuator body			
Auxiliary switches	3 (1.5)A, 230V			
Degree of protection	IP54			
Protection class	III low voltage	II	III low voltage	II
Ambient humidity	95% RH, without condensation			
Ambient temperature	-30~+50 °C			
Non-operating temperature	-40~+70 °C			
Service life	60 000 full operating cycles			
Mechanical connection				
- round shaft	from ø10 to ø20mm			
- square shaft	from 10x10 to 16x16mm			
Manual override	gears disengaged using a button on the actuator cover			
Norms and standards	Declaration of conformity, ISO, CE, EAC			

Dimensions (mm)	Electric installation
	<div style="display: flex; justify-content: space-around;"> <div style="text-align: center;"> <p>2/3 point</p>  </div> <div style="text-align: center;"> <p>Modulating (24V)</p>  </div> </div> <div style="display: flex; justify-content: space-around; margin-top: 20px;"> <div style="text-align: center;"> <p>Auxiliary switches</p>  </div> <div style="text-align: center;"> <p>Modulating (230V)</p>  </div> </div>

Actuator in position 0°
 Factory setting: a = 10°, b = 80°
 Adjustment: a: 0°~90°, b: 0°~90°

* Maximum damper surface is calculated for optimum conditions (without the influence of air flow, pressure difference, etc.).
 ** SPDT (Single-Pole Double-Throw)



Servopohon bez zpětné pružiny DA08N..., DA16N..., DA24N...

Přehled provedení

Krouticí moment	Plocha klapky	Napájecí napětí	Pomocné spínače	Model s 2/3 bodovým ovládáním	Model se spojitým ovládáním
8Nm	< 1,6m ² *	24V AC/DC	-	DA08N24	DA08N24PI
			2 SPDT**	DA08N24S	DA08N24PIS
		230V AC	-	DA08N220	DA08N220P
			2 SPDT**	DA08N220S	DA08N220PS
16Nm	< 3,2m ² *	24V AC/DC	-	DA16N24	DA16N24PI
			2 SPDT**	DA16N24S	DA16N24PIS
		230V AC	-	DA16N220	DA16N220P
			2 SPDT**	DA16N220S	DA16N220PS
24Nm	< 4,8m ² *	24V AC/DC	-	DA24N24	DA24N24PI
			2 SPDT**	DA24N24S	DA24N24PIS
		230V AC	-	DA24N220	DA24N220P
			2 SPDT**	DA24N220S	DA24N220PS

Technická specifikace

Model	DAxxN24x	DAxxN220x	DAxxN24PIx	DAxxN220Px
Krouticí moment	8Nm / 16Nm / 24Nm			
Doba přestavení - motor	30-40s / 70-95s / 115-160s			
Ovládání	2/3 bodové		0(2)-10V/0(4)-20mA DC	0 -10V DC
Napájecí napětí	24V AC/DC	230V AC	24V AC/DC	230V AC
Frekvence	50/60Hz (AC)			
Příkon				
- provozní	4,5W	4,8W	4,5W	4,8W
- v klidové poloze	0,4W	1,2W	0,7W	1,0W
- pro dimenzování	6,5VA	6,5VA	6,5VA	10,0VA
Pracovní úhel	0~90°			
- rozsah nastavení	5°~85° (5° krok)			
Směr otáčení	otočením konektoru motoru na desce elektroniky		přepínačem na desce elektroniky	
Hmotnost	1,1 kg			
Hladina akustického výk. - motor	<45 dB(A)			
Signál zpětné vazby	-		0(2)-10V DC	0 -10V DC
Elektrické připojení	svorkovnice			
Pomocné sínače	3 (1.5)A, 230V			
Stupeň krytí	IP54			
Třída ochrany	III nízké napětí	II	III nízké napětí	II
Provozní vlhkost	95% RH, bez kondenzace			
Provozní teplota	-30~+50 °C			
Skladovací telota	-40~+70 °C			
Životnost	60 000 úplných provozních cyklů			
Mechanické připojení				
- kruhový hřídel	od ø10 do ø20mm			
- čtyřhranný hřídel	od 10x10 do 16x16mm			
Ruční přestavení	možnost odpojení převodovky pomocí tlačítka na krytu servopohonu			
Normy a standardy	Prohlášení o shodě, ISO, CE, EAC			

Rozměry (mm)

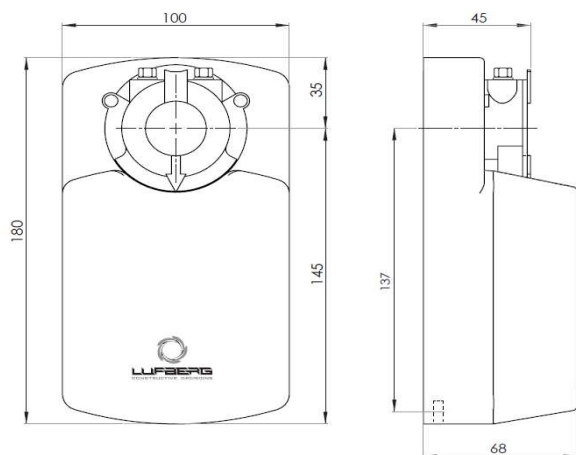

Elektrické zapojení

2/3 bodové

Spojité (24V)

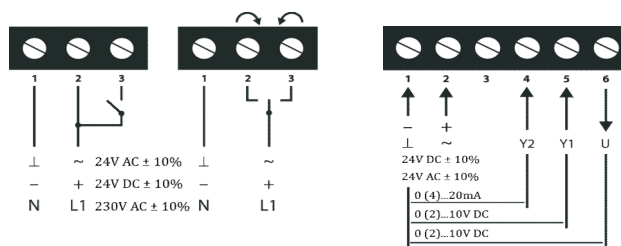

Pomocné spínače

Spojité (230V)

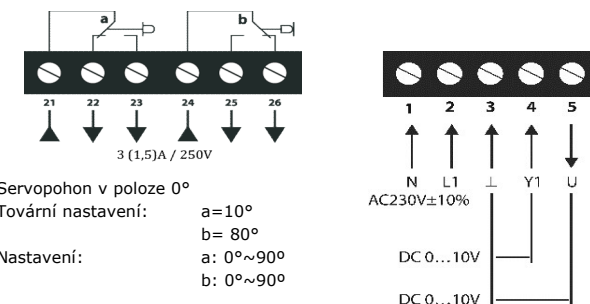

Servopohon v poloze 0°

Tovární nastavení:

a=10°

b= 80°

Nastavení:

a: 0°~90°

b: 0°~90°

* Maximální plocha klapky je počítána pro optimální podmínky (bez vlivu proudění vzduchu, rozdílu tlaků, atd.).
** SPDT (Single-Pole Double-Throw)



Siłownik bez sprężyny powrotnej DA08N..., DA16N..., DA24N...

Właściwości					
Moment obrotowy	Powierzchnia przepustnicy	Napięcie zasilające	Przełączniki pomocnicze	Model ze sterowaniem 2/3 punktowym	Model ze sterowaniem proporcjonalnym
8Nm	< 1,6m ² *	24V AC/DC	-	DA08N24	DA08N24PI
		230V AC	2 SPDT**	DA08N24S	DA08N24PIS
16Nm	< 3,2m ² *	24V AC/DC	-	DA16N24	DA16N24PI
		230V AC	2 SPDT**	DA16N24S	DA16N24PIS
24Nm	< 4,8m ² *	24V AC/DC	-	DA24N24	DA24N24PI
		230V AC	2 SPDT**	DA24N24S	DA24N24PIS

Specyfikacja techniczna				
Model	DAxxN24x	DAxxN220x	DAxxN24PIx	DAxxN220Px
Moment obrotowy	8Nm / 16Nm / 24Nm			
Czas przestawienia - silnik	30-40s / 70-95s / 115-160s			
Sterowanie	2/3 punktowe		0(2)-10V/0(4)-20mA DC	0 -10V DC
Napięcie zasilające	24V AC/DC	230V AC	24V AC/DC	230V AC
Częstotliwość	50/60Hz (AC)			
Pobór mocy				
- podczas pracy	4,5W	4,8W	4,5W	4,8W
- w spoczynku	0,4W	1,2W	0,7W	1,0W
- moc znamionowa	6,5VA	6,5VA	6,5VA	10,0VA
Kąt obrotów	0~90°			
- zakres ustawień	5°~85° (krok 5°)			
Kierunek obrotów	wybór poprzez przekręcenie złącza silnika na płycie		wybór za pomocą przełącznika na płycie elektroniki	
Ciężar	1,1 kg			
Poziom mocy akustycznej - silnik	<45 dB(A)			
Sygnal sprzężenia zwrotnego	-	0(2)-10V DC		0 -10V DC
Podłączenie elektryczne	złączki			
Przełączniki pomocnicze	3 (1.5)A, 230V			
Stopień ochrony	IP54			
Klasa ochrony	III niskie napięcie	II	III niskie napięcie	II
Wilgotność podczas pracy	95% RH, bez kondensacji			
Temperatura podczas pracy	-30~+50 °C			
Temperatura magazynowania	-40~+70 °C			
Trwałość	60 000 pełnych cykli pracy			
Przyłączenie mechaniczne				
- wałek okrągły	od ø10 do ø20mm			
- wałek czworokątny	od 10x10 do 16x16mm			
Regulacja ręczna	możliwość wyłączenia przekładni za pomocą przycisku na obudowie siłownika			
Normy i standardy	Deklaracja zgodności, ISO, CE, EAC			

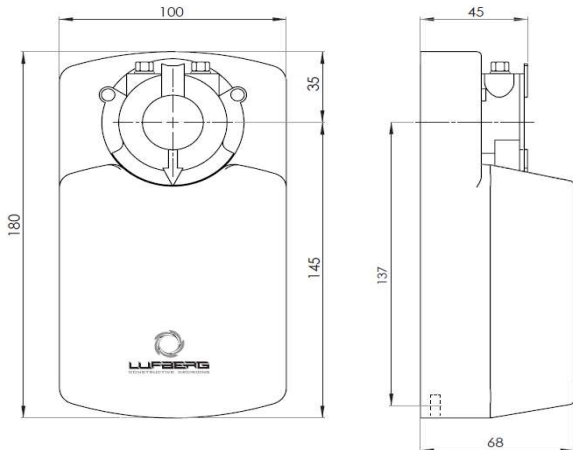
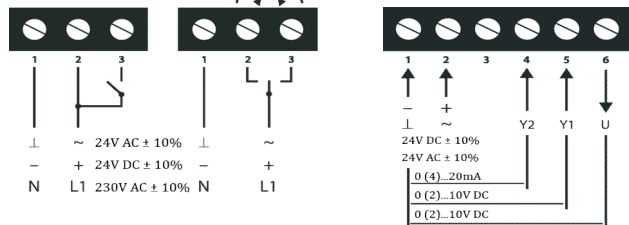
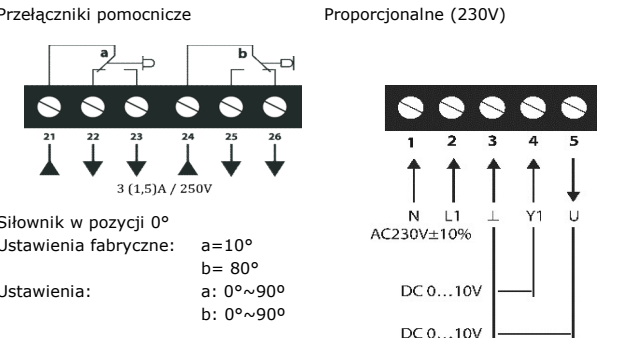
Wymiary (mm)	Podłączenie elektryczne
	<p style="text-align: center;">2/3 punktowe Proporcjonalne (24V)</p>  <p style="text-align: center;">Przełączniki pomocnicze Proporcjonalne (230V)</p>  <p style="text-align: center;">Siłownik w pozycji 0° Ustawienia fabryczne: a=10° b= 80° Ustawienia: a: 0°~90° b: 0°~90°</p>

* Maksymalna powierzchnia przepustnicy obliczona dla warunków optymalnych (bez wpływu cyrkulacji powietrza, różnic ciśnienia itd.).
** SPDT (Single-Pole Double-Throw)